



# iQuest

STANDARD • HOSPITAL • LOUNGE

Update : September 2018





In 10 years, the Quest examination couch has satisfied more than 15,000 healthcare professionals. General practitioners, cardiologists, dermatologists and physiotherapists from over 70 countries have come to appreciate

the French quality of this robust, comfortable and easy to access examination couch. Five years ago, Promotal conducted the largest survey ever performed in Europe and the Middle East. This 3-year study, carried out in collaboration with more than 200 health professionals, revealed 3 basic needs: equal treatment of people with mobility limitations, efficiency in carrying out medical examinations and user-friendly equipment. iQuest is Promotal's new revolution. We have designed an examining couch with a sleek, lightweight design that will improve your comfort and that of your patients thanks to the low position that is the lowest on the market, the programmable positions and the autonomous movements that are 2 times faster.



**ACCESS**



**EXAMINATION**



**HIGH POSITION**



**TRENDELENBURG**



**REVERSE TRENDELENBURG**



## EQUAL TREATMENT

### MAKE THINGS EASIER FOR YOUR PATIENTS WITH MOBILITY LIMITATIONS :

- > Low 46 cm position provides easier access for patients
- > Patients can use the raised backrest for support when getting on the couch
- > Safe, smooth electrical movements

### EXAMINE ALL YOUR PATIENTS EASILY :

- > Accommodates up to 250 Kg
- > Superior comfort with the Lounge upholstery



## EFFICIENT DESIGN

### YOUR EXAMINATIONS WILL GO SMOOTHLY THANKS TO

- > Movements that are 2 times faster
- > The intuitive position of the patient on the Lounge upholstery
- > The autonomous movements: Press once to change positions
- > The intuitive controls and the pre-programmed patient access position



## USER-FRIENDLY DESIGN

### CHANGE POSITIONS EFFORTLESSLY :

- > All-electric examination couch: Height, backrest, Trendelenburg / reverse Trendelenburg
- > Variable height from 46 to 93 cm
- > 2 programmable positions, 100% configurable
- > Intuitive controls built into the backrest (Lounge model)

### IMPROVE YOUR PATIENTS' COMFORT THANKS TO :

- > The superior comfort Lounge upholstery

3 MODELS,  
3 NEEDS.

● OPTIONS  
● ACCESSORIES



## iQuest STANDARD

Ref. 3050-40  
With retractable wheels  
Ref. 3050-50  
Upholstery width 65 cm  
Ref. 600150-65  
Upholstery width 75cm  
Ref. 600150-75



## iQuest LOUNGE

Ref. 3055-20



## iQuest HOSPITAL

Ref. 3050-60



Face cut-out  
65cm Ref. 2231-65  
75cm Ref. 2231-75

Factory-installed  
upholstery  
Ref. 600000-01

Battery  
Ref. 3092-01



Circuit breaker  
Ref. 3058-01

Cable reel  
Ref. 3032-01XX

Anti-static wheels  
Ref. 3031-01

Integrated plug  
EU-US-UK Ref. 30400-01

Equipotential plug  
Ref. 2059-01



Clamp  
Ref. 166

Pair of clamps on rail  
Ref. 878-12

Pair of legrests  
Ref. 840

Pair of legrest covers  
Ref. 861

Pair of stirrups  
Ref. 850



IV pole with 2 hooks  
Ref. 985-01

Auto-locking IV pole  
with 2 hooks  
Ref. 2985-01

Armrest  
(one)  
Ref. 2536

Armrest cover  
(one)  
Ref. 2537

Lounge headrest  
Ref. 30679-01



Flat upholstery headrest  
Ref. 1102-10

Adjustable paper roll  
holder  
Ref. 2056-02

Backrest extension  
Ref. 2055-01

Wired foot control  
Ref. 3051-10

Plastic cover (foot end)  
for flat upholstery  
65cm Ref. 600150-65C  
75cm Ref. 600150-75C



Plastic cover  
(head end)  
Ref. 3056-02

Plastic cover  
(foot end)  
Ref. 3056-01

Pair of barriers  
Ref. 85114-01

Pair of head rails  
Ref. 30878-XXT

Pair of foot rails  
Ref. 30878-XXP

# iQuest

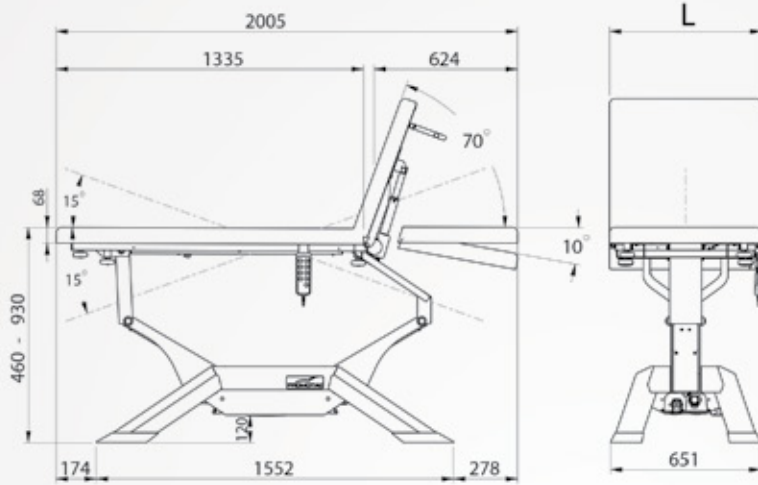

STANDARD

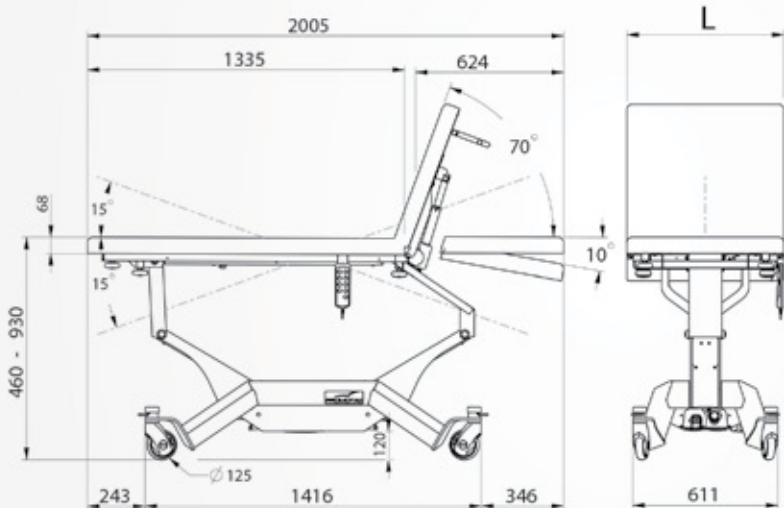



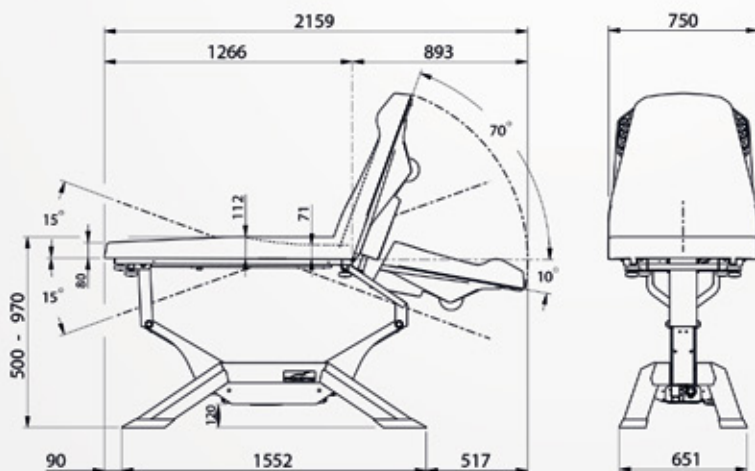















HOSPITAL



LOUNGE

## COLORS OF UPHOLSTERIES & COUNTERPLATES

- |                   |   |         |
|-------------------|---|---------|
| 32 - BLUE *       |    | CLASSIC |
| 93 - COTTAGE *    |    |         |
| 35 - RED *        |    |         |
| 34 - YELLOW *     |    |         |
| 91 - WHITE        |    | VITAMIN |
| 92 - MARINE *     |    |         |
| 56 - DARKNESS     |   |         |
| 57 - ANTISTATIC   |  |         |
| 64 - GRAPE        |  | COSY    |
| 67 - LAGOON       |  |         |
| 66 - SWEET *      |  |         |
| 63 - CEDRAT       |  |         |
| 80 - SKY          |  |         |
| 81 - SEA GREEN *  |  |         |
| 65 - LILAC *      |  |         |
| 96 - TIN *        |  |         |
| 82 - MOUSE GREY * |  |         |
| 83 - NATURAL      |  |         |
| 84 - CHOCOLATE *  |  |         |

\*Colors benefiting from a matching counterplate. The other colors are equipped with a white counterplate



22 rue de Saint-Denis-de-Gastines - 53500 Ernée, FRANCE  
 Phone : + 33 (0)2 43 05 68 95  
 Fax : + 33 (0)2 43 05 72 00

Distributed by:



DESIGNED WITH YOU IN MIND

A1/2A Westall Road Clayton Victoria 3168 T: 1300 442 662 W: www.icona.net.au