



DIVAN À HAUTEUR VARIABLE
HYDRAULIQUE
VARIABLE HEIGHT HYDRAULIC TABLE

HYDR



Version : 01-2019



CONFORT COMFORT

- Dossier réglable par vérin à gaz
- Divan autonome : aucun branchement nécessaire
- Économie d'énergie
- Rapidité en descente
- Possibilité d'adapter de nombreux accessoires
- Gas spring assisted backrest
- Autonomous couch : No connection necessary
- Energy saver
- Fast descent
- Possibility to adapt many accessories

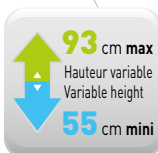

HYGIÈNE HYGIENE

- Bâti sans aspérité et simple à nettoyer
- Revêtement avec protection antibactérienne (suivant choix de couleur, voir nuancier)
- Support rouleau papier
- Roues de déplacement (en option)
- Frame easy to clean
- Covering with antibacterial protection (depending on the color, see color chart)
- Paper roll holder
- Casters for occasional move (option)



SÉCURITÉ / SAFETY

- Capacité 200 kg
- Sellerie non-feu M1 (suivant choix de couleur, voir nuancier)
- Absence de risque d'interférences avec les appareils électriques et/ou électroniques
- Compatible dans les Centres Hospitaliers Spécialisés (pas de cordon)
- Capacity : 200 kg
- M1 fire retardant upholstery (depending on the color, see color chart)
 - No interferences possible with electric or electronic appliances
 - Compatible in Psychiatric Hospital (no cords)

ACCESSIBILITÉ ACCESSIBILITY

- Hauteur variable hydraulique de 55 à 93 cm
- 12 cm de dégagement au sol
- Compatible avec le passage d'un lève-personne
- Variable height from 55 to 93 cm
- 12 cm clearance
- Compatible with a hoist



Accueil
Welcome



Position haute
High position



Examen général
General examination



Avec barrières
With barriers

CARACTÉRISTIQUES STANDARD

Hauteur variable hydraulique de 55 à 93 cm
 Structure acier avec finition époxy gris nuage
 Dossier réglable par vérin à gaz
 Patins de réglage sous piètement (réf. 1050-10)
 Block'n Roll® - Système de roulettes escamotables intégrées semi-centralisé (réf. 1050-15)
 Support rouleau papier (côté tête) longueur maxi 50 cm - ø 20 cm
 Poids maximum du patient autorisé 200 kg (testé en dynamique à 250 kg et en statique à 800 kg)

STANDARD FEATURES

Hydraulic height adjustment from 55 to 93 cm
 Steel frame structure with light grey epoxy finish
 Gas-spring assisted backrest
 Adjustable levellers under base (model 1050-10)
 Block'n Roll® - Built-in retractable castor system semi centralized (model 1050-15)
 Paper roll holder (head end) max length 50 cm - ø 20 cm
 200 kg patient weight capacity (tested at a dynamic weight of 250 kg and a static weight of 800 kg)



Ce produit est un divan d'examen et n'est pas adapté au transfert de patients
 This is a couch and therefore not allowed for patient transfer

Modèles Models	Patins Levellers	Block'n Roll®
1050-10	●	
1050-15		●

Selleries Upholstery

Tous modèles, à commander séparément
 All models, to order separately

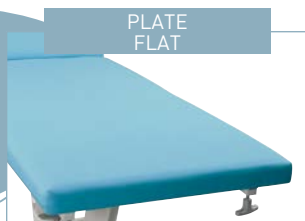

PLATE
FLAT

Largeur / Width 65 cm..... 600150-65
 Largeur / Width 75 cm..... 600150-75



A BOURRELETS
LATERAL PADDINGS

Largeur / Width 65 cm..... 600151-65
 Largeur / Width 75 cm..... 600151-75



ANATOMIQUE
FORMED

Largeur / Width 73 cm..... 600150-70

Options*

* A demander impérativement lors de la commande, montage usine
 Plant installed, must be ordered with initial order



81036

4 roues à frein double galets ø 50
 Set of 4 double castors with brakes ø50 (réf./ref: 1050-10)



2231-65 2231-75
 Sellerie/upholstery 65 cm Sellerie/upholstery 75 cm

Trou pour visage Face cutout in head cushion uniquement sur sellerie plate only with flat upholstery 600150-65 / 600150-75



600000-01

Montage de sellerie en usine
 Factory assembly fitting of upholstery

Accessoires Accessories



166

Paire d'étau
 Pair of clamps



840+166

Paire d'appui-jambes
 Pair of legrests

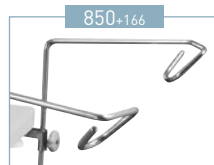

850+166

Paire d'étriers
 Pair of stirrups



861

Paire de housses pour appui-jambes
 Pair of covers for legrests



2536+166

Appui-bras (unitaire)
 Armrest (unit)



2537

Housse pour appui-bras (unitaire)
 Cover for armrest (unit)



2054-01

Appui-tête / Headrest
 Non compatible avec la sellerie à bourrelets / Not compatible with lateral paddings upholstery



2055-01

Rallonge de dossier
 Backrest extension



1102-10

Appui-tête
 Headrest



2985-01+166

Tige porte-sérum autobloquant 2 crochets
 Auto-locking 2 hook IV pole



985-01+166

Tige porte-sérum 2 crochets
 2 hook IV pole



85114-01

Paire de barrières
 Pair of barriers
 Non compatible avec les accessoires / Not compatible with accessories 166, 985-01, 2985-01



2056-02

Porte-rouleau réglable (côté tête) / Adjustable paper-roll holder (head-end) (350-800 mm, ø 200 mm)



2057-02

Porte-rouleau réglable (côté pied) / Adjustable paper-roll holder (foot-end) (350-800 mm, ø 200 mm)

Choix de selleries non-feu M1
Antibactérien
Choice of M1 fire retardant
and antibacterial upholstery

Classic

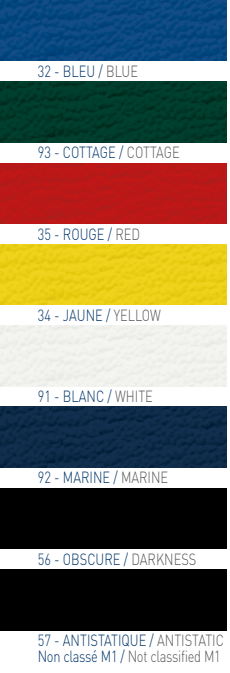

Vitamin

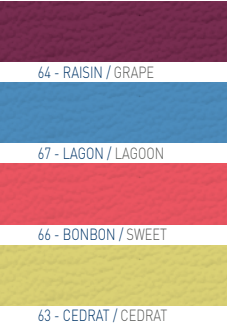

Cosy

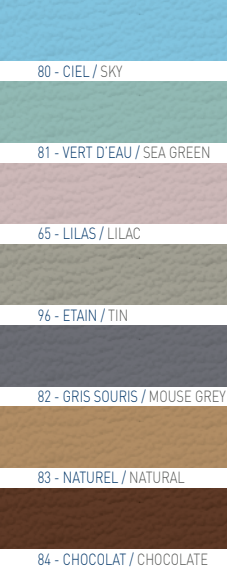

ANTIBACTERIEN / NON FEU M1 - ANTIBACTERIAL / M1 FIRE RETARDANT

Poids net
Net weight
82 kg

Poids brut
Gross weight
112 kg

Volume
1,036 m³

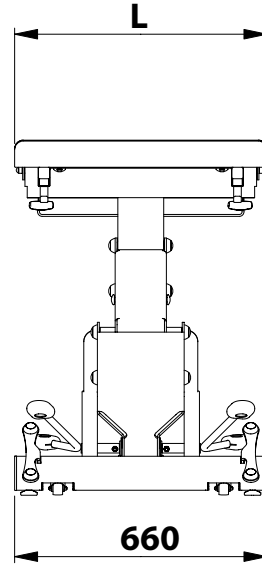

Modèles / Models 1050-10 / 1050-15

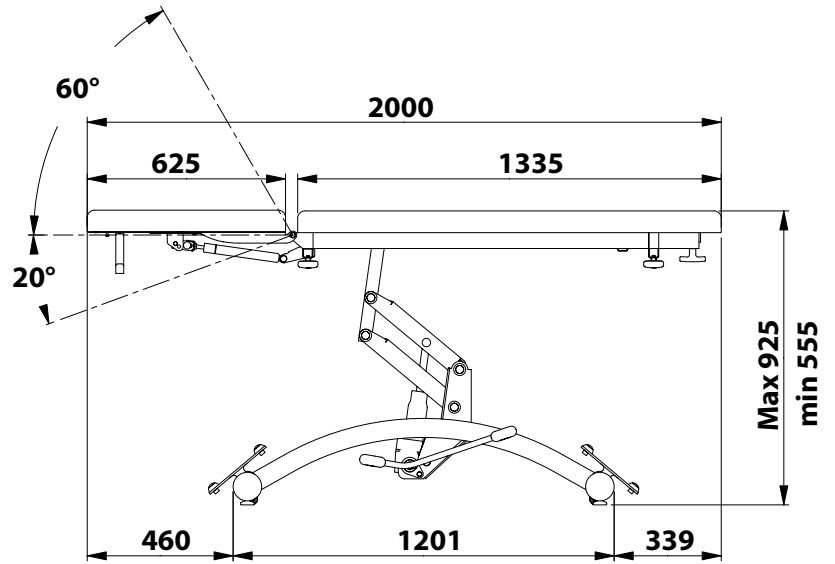

FE-04/19

