



BRANCARD DE TRANSFERT  
À HAUTEUR VARIABLE

VARIABLE-HEIGHT  
TRANSFER STRETCHER

*Elineo*



# Elineo

Maniable, modulable, sécurisé, facile d'usage et offrant un confort optimal pour vos patients, ELINEO, le nouveau brancard de transfert vous apporte les fonctions essentielles dont vous avez vraiment besoin !

The new ELINEO transfer stretcher fulfils all the essential functions that you really need. It is easy to manoeuvre, safe, easy to use and keeps your patients perfectly comfortable.

## CONFORT / COMFORT

- Ultra maniable : grande facilité de déplacement
- Mise en place des barrières facile et sécurisée
- Barres de poussée disponibles en standard côté tête et côté pied
- Plan de couchage disponible en 4 dimensions et en 2 épaisseurs de matelas (selon version)
- 5<sup>e</sup> roue nouvelle génération pour une meilleure adhérence et efficacité (en option)
- Compatible bed mover\*
- Ergonomic cotsides ensure easy operation
- Easy and secure installation of the side rails
- Push bars at the head and foot ends come as standard
- Various mattresses available to suit customers requirements
  - New-generation fifth castor for better grip and improved performance (option)
    - compatible with most bed movers\*

## ACCESSIBILITÉ ACCESSIBILITY

- Hauteur variable de 57 à 90 cm\*\*
- Commandes d'élévation faciles à manipuler des 2 côtés du brancard
- Grand espace de rangement sous le plan de couchage (en accessoire)
- Variable height from 57 to 90 cm\*
- Easy-to-use elevation controls on both sides of the stretcher
- Large storage facility within the optional oxygen cylinder holder base

\*\* Hauteur sans matelas / Height without mattress



Modèle présenté avec options/accessoires  
Product shown with options/accessories

## SÉCURITÉ / SAFETY

- Capacité de charge jusqu'à 250 kg
- Proclive / Déclive accessible par commandes bilatérales
- Freinage centralisé aux 4 coins du brancard
- Barrières verticales en inox
- Compatible barrières pédiatriques
- Load capacity of up to 250 kg
- Trendelenburg / Reverse Trendelenburg controls on both sides
  - Centralised brakes at the four corners of the stretcher
    - Stainless steel robust cotsides
    - Compatible with paediatric siderails

## HYGIÈNE / HYGIENE

- Matelas amovible, étanche et antiallergique
- Structure simple sans aspérité et facile à nettoyer
- Carter de protection amovible et facilement démontable sans outils (en accessoire)
- Barrières en acier inoxydable
- Waterproof, anti-allergy mattress
- Simple structure without any protruding parts and easy to clean
- Detachable oxygen bottle holder base that can be removed without any tools (accessory)
  - Stainless Steel cotsides



Position basse  
Low position



Transfert  
Transfer



Proclive  
Reverse trendelenburg



Déclive  
Trendelenburg



Position haute  
High position

## CARACTÉRISTIQUES STANDARDS

Hauteur variable de 57 à 90 cm (sans matelas)  
 Procline / Décline accessible par commandes bilatérales  
 Structure acier revêtement époxy polyester gris nuage  
 Plan dur en résine radio transparent compatible C-arm  
 4 roues ø 200 mm avec freinage centralisé, dont 2 directionnelles côté tête (commandé aux 4 coins)  
 Dossier relevable par double vérin à gaz  
 4 pare-chocs latéraux + bandes de protection latérale  
 4 supports accessoires  
 Barrières repliables sous le niveau de couchage  
 Poignées de poussée  
 Poids maximum du patient autorisé 250 kg  
**Livré sans matelas**

## STANDARD FEATURES

Variable height from 57 to 90 cm (without mattress)  
 Trendelenburg / Reverse Trendelenburg controls on both sides  
 Polyester epoxy-coated steel structure, cloud grey  
 X-ray translucent resin mattress base, C-arm compatible  
 Four ø 200 mm castors with centralised braking, two steering castors at the head end (controls on all four corners)  
 Dual gas actuator adjustable backrest  
 Four corner bumpers and protective bumpers along the sides  
 Four accessory sockets  
 The Cot sides fold away neatly beside the mattress  
 Push handles  
 Patient weight capacity: 250 kg  
**Various mattress options available to suit specific requirements**

Modèles Models	Longueur Length 190 cm	Longueur Length 205 cm	Largeur Width 66 cm	Largeur Width 75 cm
15245-10M	●		●	
15245-10L	●			●
15745-10M		●	●	
15745-10L		●		●

### Options\*

\* A demander impérativement lors de la commande, montage usine / Plant installed, must be ordered with initial order



5<sup>e</sup> roue directionnelle  
Fifth steering castor



1 jeu de 2 roues antistatiques  
One set of two anti-static castors



Roulettes « Roll+ »  
« Roll+ » castors



Tige porte-sérum  
télescopique repliable  
2 crochets  
Folding IV pole 2 hooks



Poignées repliables  
côté tête  
Folding handles  
at the head end



Poignées repliables côté pied  
(incompatible avec le  
porte-dossier patient)  
Folding handles at the foot  
end (not compatible with the  
patient notes holder)

### Accessoires Accessories

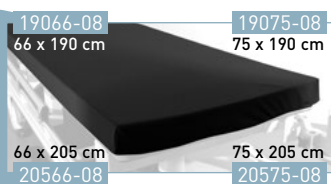

Épaisseur matelas / Mattress thickness  
**8 cm**

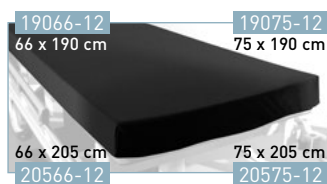

Épaisseur matelas / Mattress thickness  
**12 cm**



Butées de maintien  
pour matelas  
Mattress stoppers



Paire de protections  
pédiatriques pour barrières  
Pair of padded cot side  
bumpers



Porte-rouleau réglable  
Adjustable paper-roll holder  
(350-750 mm)

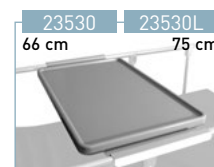

Tablette repas  
Dining tray

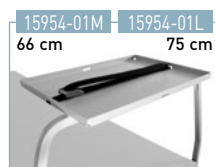

Tablette support  
monitoring  
Monitor support tray



Porte-dossier patient  
(incompatible avec Réf. 15956-01)  
Patient note holder  
(incompatible with Ref. 15956-01)

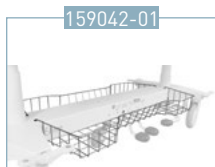

Panier de rangement  
latéral en inox (G ou D)  
Lateral s/s clothes basket  
(L or R)

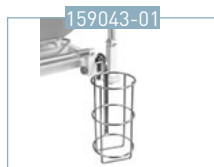

Porte bouteille B2  
Oxygen bottle holder B2



Porte bouteille B5  
(incompatible avec  
Réf. 15955-01 et 15956-01)  
Oxygen bottle holder B5  
(incompatible with  
Ref. 15955-01 & 15956-01)



Cartier amovible  
porte-bouteille oxygène  
(dim. D, E, F)  
Removable oxygen bottle  
holder base (dim. D, E, F)



Tige porte-sérum  
autobloquant 2 crochets  
Auto-locking 2 hook IV pole

Couleurs de matelas  
non-feu M1 - Antibactérien  
Mattress colors  
of M1 fire retardant upholstery  
antibacterial

Matelas soudé  
Welded mattress

NOIR / BLACK



15245-10M  
+ 19066-08

Poids net  
Net weight  
99 kg\*

Poids brut  
Gross weight  
147 kg\*

Volume  
1,45 m<sup>3</sup>

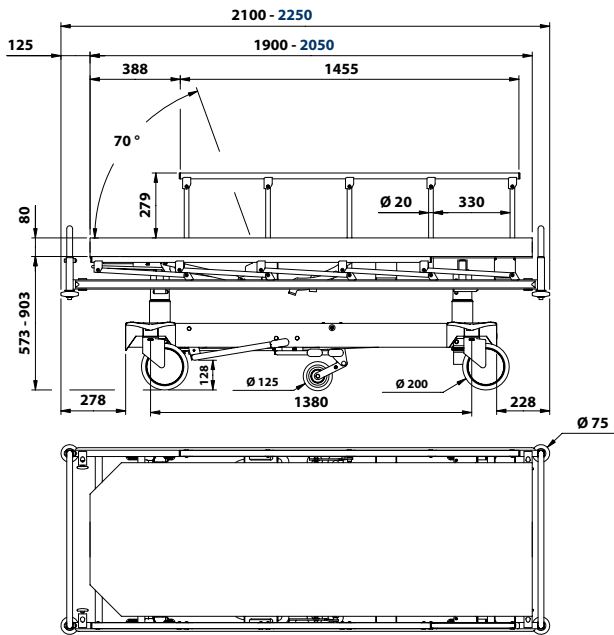

Largeur 66 cm  
Width 66 cm

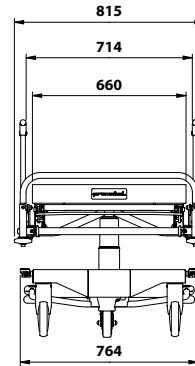

Largeur 75 cm  
Width 75 cm

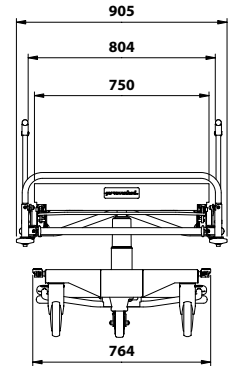

Proctive / décline : 14°  
Trendelenburg / reverse trendelenburg: 14°

\* Poids « nu » :  
sans matelas,  
sans carter, sans tige  
porte-sérum.  
Version : 66 x 190 cm

\* Weight when bare:  
without the mattress,  
housing and IV pole.  
Version: 66 x 190 cm

FE-41/18