



TABLE GYNÉCOLOGIQUE ÉLECTRIQUE
ELECTRIC GYNECOLOGICAL TABLE

ELANSA



Version : 11-2015



ELANSA

L'EFFICACITÉ
ET LA SIMPLICITÉ D'UTILISATION
THE EFFICIENCY EASY TO USE

CONFORT COMFORT

- 1 moteur électrique
- Dossier réglable par vérin à gaz
- Ancrages bilatéraux pour colposcope
- Mouvement combiné de l'élévation et du dossier
- Commande au pied (commande programmable en option)
- 1 actuator
- Gas-spring assisted backrest
- Bilateral receptacle for optional colposcope holder
- Combined motion of the height and backrest
- Foot control (programmable foot control as an option)



SÉCURITÉ / SAFETY

- Capacité 170 kg
- Position d'urgence 11°
- Borne d'équipotentialité : permet l'égalisation des potentiels entre différents dispositifs électromédicaux
- Capacity 170 kg
- Emergency position 11°
- Equipotential bonding conductor: enables to equalise the potentials between different electromedical devices



HYGIÈNE HYGIENE

- Sellerie anatomique sans couture monobloc
- Sellerie amovible
- Structure inox époxy sous assise
- Carters ABS sur la base
- Support rouleau papier
- Bac ABS stérilisable
- Bac coulissant et amovible
- Coussin d'assise étanche
- Roulettes à freins (option)
- Formed seamless upholstery in one piece
- Removable upholstery
- S/S epoxy coated structure under the seatrest
- ABS carter on the base
- Paper roll holder
- Sterilisable ABS bowl
- Sliding and removable bowl
- Waterproof seatrest
- Casters with brakes (option)



Modèle présenté avec options/accessoires
Products shown with options/accessories

ACCESSIBILITÉ ACCESSIBILITY

- Hauteur variable électrique de 46 à 106 cm
- Décrochement de la base pour s'approcher du patient
- Possibilité de pratiquer un examen général (coussin en accessoire)
- 3 modèles pour s'adapter à toutes les pratiques (Étriers, Goeppel, Repose-pieds)
- Variable height from 46 to 106 cm
- Cutout in the base for more accessibility to patient
- Versatility of the table (gynecology and general examination with the cushion as accessory)
- 3 models to adapt to various practices (Stirrup, Goepfels, Footrests)



Accueil
Welcome



Examen général
General examination



Gynécologie
Gynecology



Position d'urgence
Emergency position

CARACTÉRISTIQUES STANDARD

Hauteur variable électrique de 46 à 106 cm
 Mouvements combinés de l'élévation et du dossier (1 moteur)
 Inclinaison du dossier par vérin à gaz
 Commande par pédale
 Patins de réglage sous piètement
 Bac ABS stérilisable, coulissant et amovible (capacité 6 litres)
 Ancrage bilatéral pour option support colposcope
 Structure inox avec finition époxy gris nuage sous assise
 Carter ABS gris clair
 Sellerie anatomique amovible sans couture
 Support rouleau papier (longueur maxi 50 cm - ø 12,5 cm)
 Poids maximum du patient autorisé 170 kg
 (testé en dynamique à 210 kg et en statique à 680 kg)

STANDARD FEATURES

Electric height adjustment from 46 to 106 cm
 Combined height and backrest movements (1 actuator)
 Gas-spring assisted backrest adjustment
 Foot control
 Adjustable levlers under the base
 Sterilisable, sliding and removable ABS bowl (capacity 6 litres)
 Bilateral receptacle for optional colposcope holder
 Stainless steel structure, under the seatrest, with light grey epoxy finish
 Light grey ABS carter
 Removable formed seamless upholstery
 Paper roll holder (max. length 50 cm - ø 12,5 cm)
 170 kg maximum patient weight capacity (tested at a dynamic weight of 210 kg and a static weight of 680 kg)

Modèles Models	Goepfels	Goepfels	Étriers Stirrups	Repose-pieds Footrest
11614-01	●			
11610-01			●	
11615-01				●

Options*

* A demander impérativement lors de la commande, montage usine / Plant installed, must be ordered with initial order



4 roulettes ø 5 cm avec freins (Hauteur + 5 cm)
 4 castors ø 5 cm with brakes (Height + 5 cm)

Accessoires Accessories



Support accessoire ø 16 mm
 Accessory holder ø 16 mm



Se référer à la documentation
 Refer to the literature



Tige porte-sérum autobloquant 2 crochets
 Auto-locking 2 hook IV pole



Coussin de pied amovible avec son support mural
 Removable leg cushion with wall support (pour/for 11610-01 & 11614-01)



Appui-tête
 Headrest



Coussin d'obturateur avec support
 Fill-in cushion with support (pour/for 11615-01)



Grille anti-éclaboussures
 Splash guard cover



Support colposcope Olympus
 Olympus colposcope holder
 8850-01 : droit - right
 8851-01 : gauche - left
 Seulement pour 11614-01
 Only for 11614-01



Support colposcope Zeiss ø 38
 Zeiss colposcope holder ø 38









Support colposcope Leisegang
 Leisegang colposcope holder



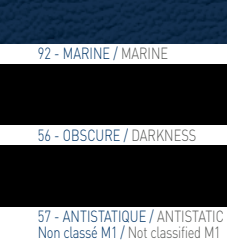

D'autres modèles de supports coloscopes sur demande
 Other colposcope holders available on request

Choix de selleries non-feu M1
Antibactérien
Choice of M1 fire retardant
and antibacterial upholstery







Classic

-  32 - BLEU / BLUE
-  93 - COTTAGE / COTTAGE
-  35 - ROUGE / RED
-  34 - JAUNE / YELLOW
-  91 - BLANC / WHITE
-  92 - MARINE / MARINE
-  56 - OBSCURE / DARKNESS
-  57 - ANTISTATIQUE / ANTISTATIC
Non classé M1 / Not classified M1

Vitamin

-  64 - RAISIN / GRAPE
-  67 - LAGON / LAGOON
-  66 - BONBON / SWEET
-  63 - CEDRAT / CEDRAT

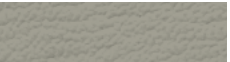
Cosy

-  80 - CIEL / SKY
-  81 - VERT D'EAU / SEA GREEN
-  65 - LILAS / LILAC
-  96 - ETAIN / TIN
-  82 - GRIS SOURIS / MOUSE GREY
-  83 - NATUREL / NATURAL
-  84 - CHOCOLAT / CHOCOLATE

ANTIBACTÉRIEN / NON FEU M1 - ANTIBACTERIAL / M1 FIRE RETARDANT



Poids net
Net weight
95 kg

Poids brut
Gross weight
135 kg

Volume
0,92 m³

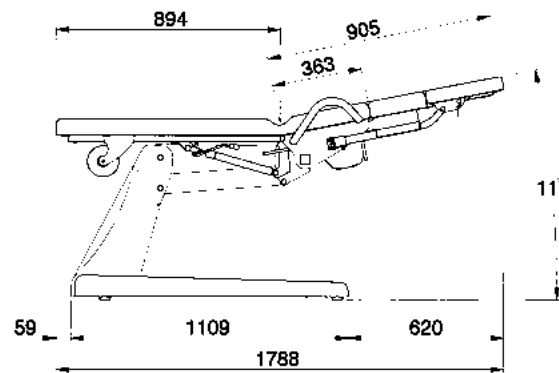
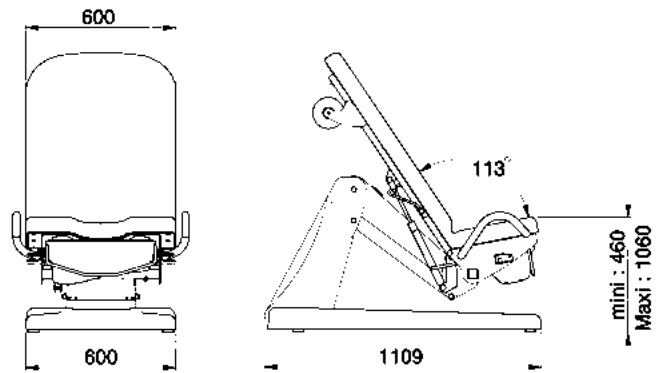

FE-47/15